

M110A

RF MODEM

M110A

User's Manual

Ver 2.0

SEBINE Technology, Inc.

M110A

CONTENTS

1. Summary
 - 1.1 Product Introduction
 - 1.2 Specification

 2. Operation Mode
 - 2.1 PC MODE
 - 2.2 DEVICE MODE

 3. Device Connection
 - 3.1 Power Supply
 - 3.2 RS232 Communication Connection
 - 3.3 RS485 Communication Connection
 - 3.4 Serial Communication Speed Setup
 - 3.5 RS232/RS485 Communication Setup
 - 3.6 Antenna Connection

 4. Environment Setup
 - 4.1 Hardware Connection
 - 4.2 Setup List of Each Mode

 5. Examples
- Appendix 1. Dimension
Appendix 2. R&TTE
Appendix 3. Document Information

M110A

1. Summary

1.1 Product Introduction

M110A is a RF MODEM which uses ISM 433MHz frequency bandwidth. M110A has a function of RF transmission and reception and provides serial communication interface. When a user transmits data through a serial port by designated protocol, M110A transmits data by wireless communication. M110A allows users to set PC MODE, DEVICE MODE, and communication channels via environment setting. Usable frequency number, channel number, and serial number are printed in shipping products.

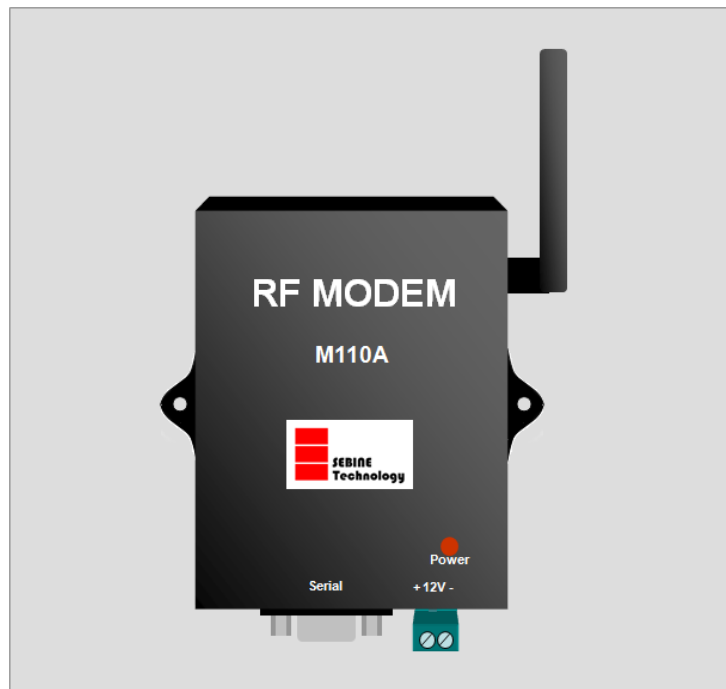

Figure 1. M110A

M110A

1.1.1 Application examples

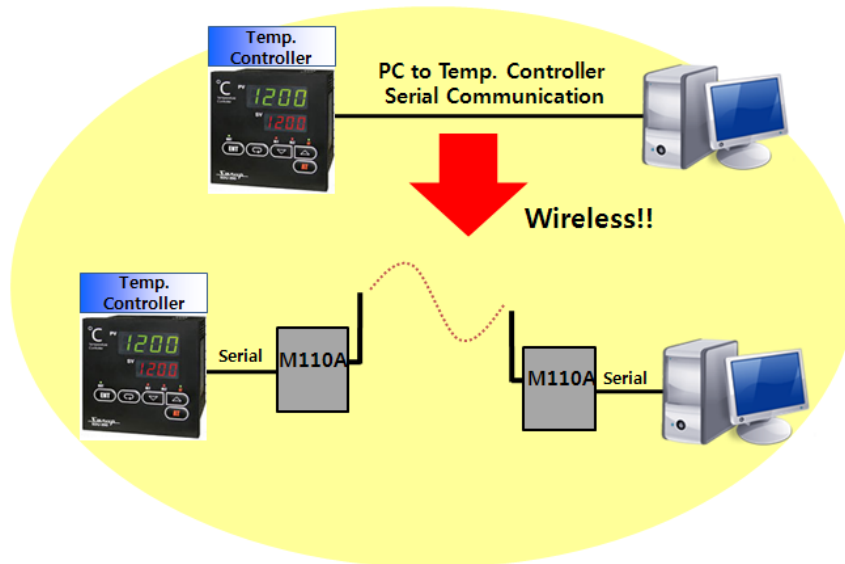

Figure 2. Wireless Serial Communication

1.1.2 Product usage

- Cable system replacement : Maintenance difficulty with cables is solved
- Hard environment for cable installation : Environment that requires long and complicated cable installation is solved
- Uneasy area for data acquisition by cable : Outdoor tank monitoring system

1.1.3 Product application area

- Pump, pipeline, liquid flow monitoring system
- Tank level, temperature monitoring system
- Poison gas detection and monitoring system
- Weather data (rainfall, wind direction, wind velocity, humidity, temperature) monitoring system

1.1.4 Product parts

M110A main body, one $\lambda/4$ dipole antenna, one power connector

M110A

1.2 Specification

Item	Specification
Name	M110A
Dimension	88.1mm(L)×85mm(W)×19.6mm(H) (w/o Antenna, Connector)
Housing	Aluminum
Weight	140g (w/o Antenna)
Power Supply	+12Vdc ±10%, Reverse Power/Overvoltage/Overcurrent Protection
Current Consumption	Tx 94mA, Rx 88.5mA, WDT Reset 114mA (@12Vdc)
Operating Temperature	-10℃ ~ +60℃
RF Features	<ul style="list-style-type: none">. Frequency : 433.050MHz ~ 434.790MHz. Channel Spacing : 25KHz. Transmitter Power : 10mW. Receiver Sensitivity : -116 ~ -120dBm(-116dBm typ.). Modulation : FSK. Bandwidth : < 14KHz
Performance	<ul style="list-style-type: none">. Expected Line-Of-Sight Range : Up To 1.5km with $\lambda/4$ Dipole Antenna. RF Data Rate : 4.8K Baud, 7.2K Baud
I/O Interface	<ul style="list-style-type: none">. RS232/RS485 Selectable. Serial Communication Basic Setting(User Selectable) : Data Bit 8bit, No Parity, 1 Stop Bit. User Selectable Baud Using DIP Switch: 1200, 2400, 4800, 9600, 19200, 38400, 57600, 115200. 9Pin D-SUB Female Connector
Antenna Interface	<ul style="list-style-type: none">. SMA Connector. Impedance 50Ω

Table 1. M110A Specification

M110A

2. Operational mode

M110A allows PC MODE and DEVICE MODE for users' personal need. Function Code and its functionality is restricted based upon selected mode. Refer the Programmer guide for detailed protocol and Function Code.

2.1 PC MODE

2.1.1 Definition of PC MODE

Data is transmitted when data is sent through serial port by selected protocol function.

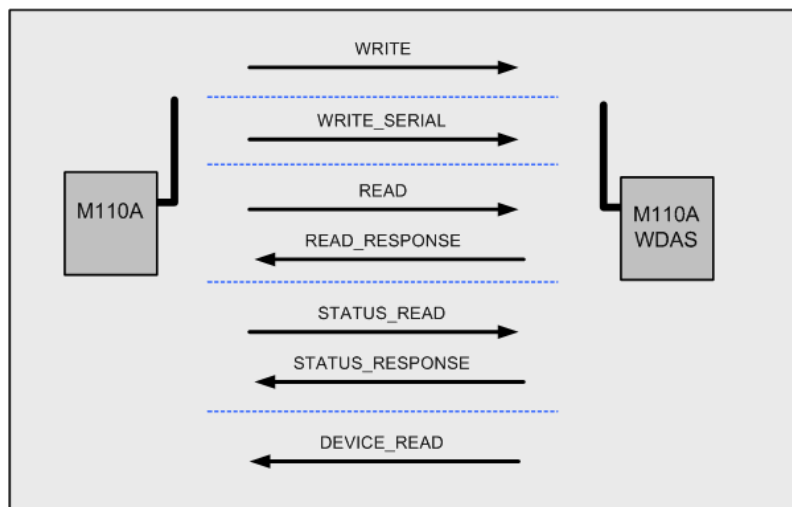

Figure 3. PC MODE of M110A

2.1.2 Function Code available at PC MODE

- WRITE : WDAS device output DO[Digital Output], AO[Analog Output]
- WRITE_SERIAL : Transmit serial data to RF MODEM or W110A where serial port is available
- READ : WDAS device reads the status of DI[Digital Input], AI[Analog Input]
- READ_RESPONSE : Function Code of READ_RESPONSE is used when WDAS device receives READ Function Code and transmits current input status.
- STATUS_READ : WDAS device reads the status of DO[Digital Output], AO[Analog Output]
- STATUS_RESPONSE : Function Code of READ_RESPONSE is used when WDAS device receives STATUS_READ Function Code and transmits current output status.
- DEVICE_READ : WDAS receives and output through Serial Port when DEVICE MODE available WDAS periodically transmits data of DI[Digital Input], AI[Analog Input]

2.1.3 Environment setting list before PC MODE use

M110A

- Select PC MODE at PC/DEVICE MODE Setting

2.2 DEVICE MODE

2.2.1 Definition of DEVICE MODE

When the device that has usable PC MODE/DEVICE MODE as Serial Port is set as DESTINATION and data is input to Serial Port at once, data are transmitted automatically.

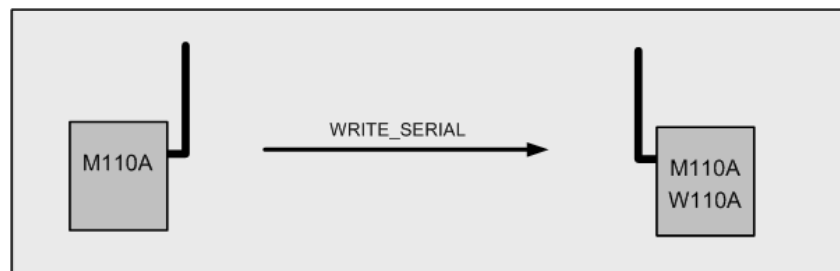

Figure 4. DEVICE MODE of M110A

2.2.2 Function Code available at DEVICE MODE

- WRITE_SERIAL : When Data obtained through Serial Port are transmitted to established DESTINATION device, Function Code of WRITE_SERIAL is used.

2.2.3 Environment setting list before DEVICE MODE use

- DEVICE MODE selection at PC/DEVICE MODE Setting
- DESTINATION ID set up at DESTINATION ID Setting

M110A

3. Device Connection

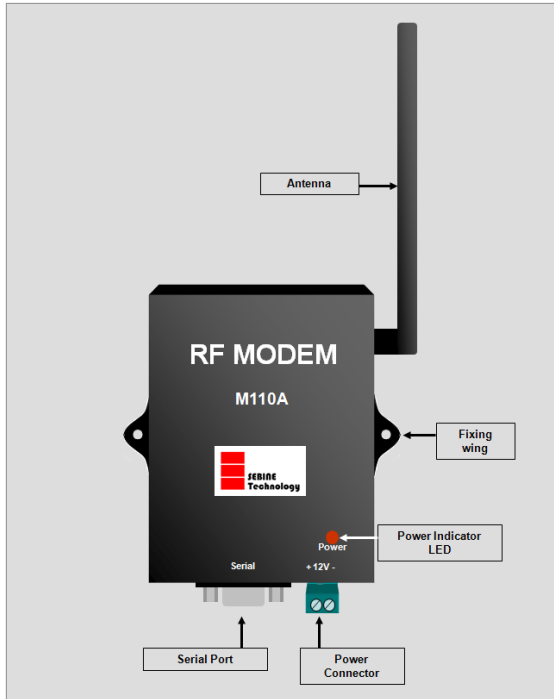

Figure 5. M110A Outer

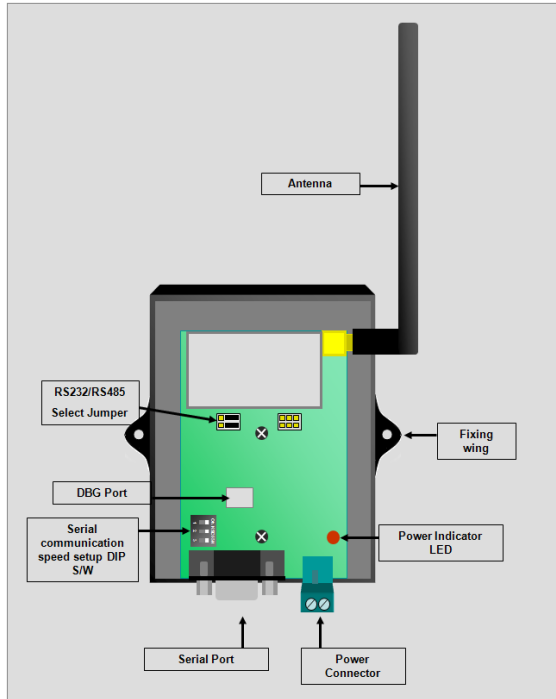

Figure 6. M110A Inner

M110A

3.1 Power Supply

M110A works at +12Vdc and equipped with Reverse Power / Overvoltage / Overcurrent Protection circuitry. Power is supplied by power connector provided at product purchase as shown in figure below. M110A has no external power switch and it becomes in working mode when the power is supplied. If normal power is supplied, power supply indicator LED is on.

- a. As shown in Figure 7, remove the skin of wire about 7mm and put it into the terminal and tighten it by turning the left screw using screwdriver.
- b. As shown in Figure 8, connect it to power.
- c. As shown in Figure 9, connect the terminal to power port of M110A, Make sure the direction is exact as shown in Figure 9.

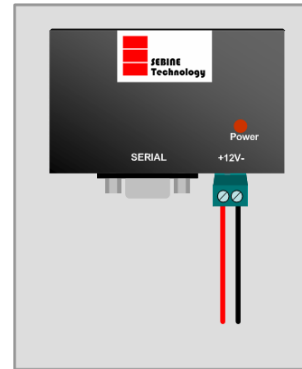
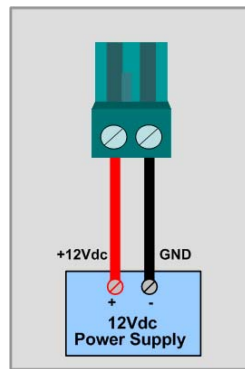
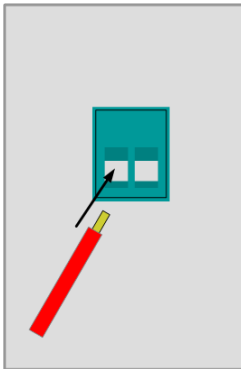

Figure7. Power Supply-1 Figure8. Power Supply-2 Figure9. Power Supply-3

※ Notice

Readily accessible disconnect device shall be incorporated external to the equipment.

M110A

3.2 RS232 Communication Connection

3.2.1 PC Communication

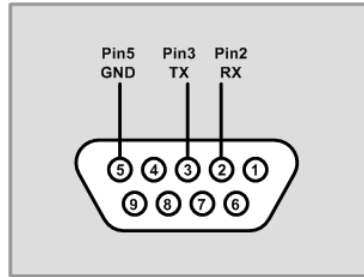
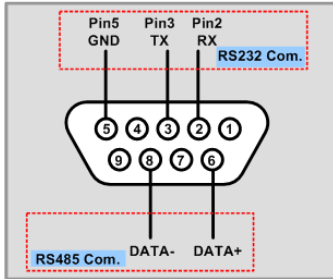

Figure 10. M110A Connector : DB-9 Female

Figure 11. PC Connector

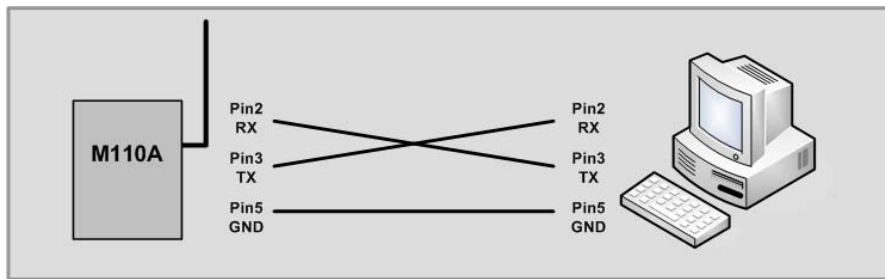

Figure 12. Connection of M110A and PC

3.2.2 DEVICE Connection

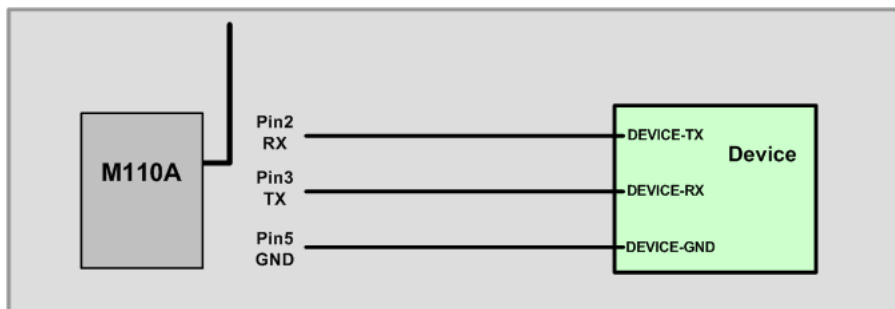

Figure 13. Connection of M110A and DEVICE

M110A

3.3 RS485 Communication Connection

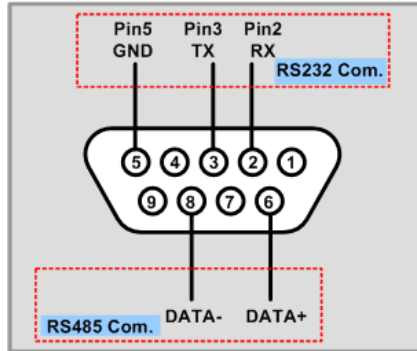

Figure 14. M110A Connector : DB-9 Female

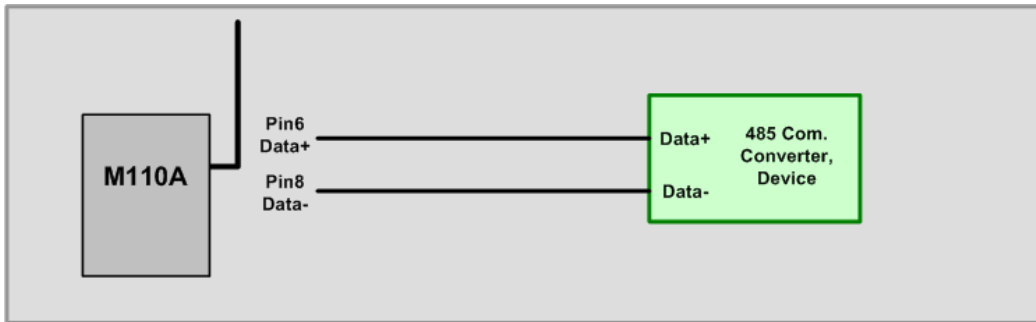

Figure 15. Connection of M110A and RS485 Communication

3.4 Serial communication speed setup

M110A is able to adjust serial communication speed with DIP switch as shown in Figure 16. Serial communication adjustment must be set before power is supplied. During the operation, if the communication speed is to be reset, DIP switch is set and then power should be OFF/ON afterward.

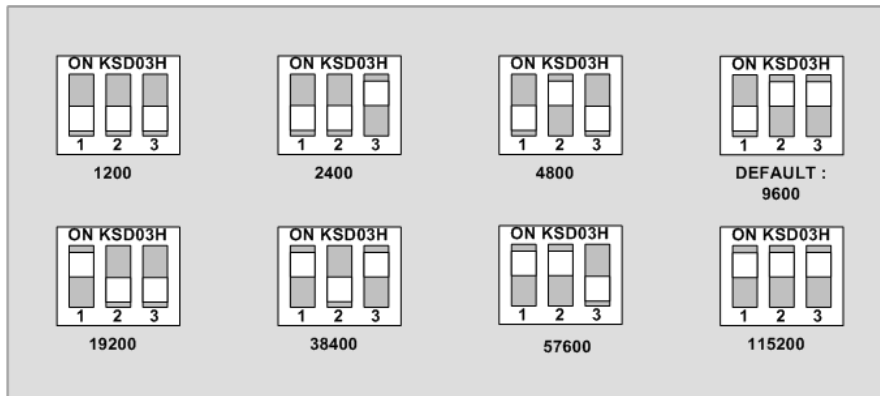

Figure 16. Communication speed adjustment with DIP switch

M110A

3.5 RS232/RS485 communication setup

M110A is able to set the serial communication method by RS232/RS485 jumper shown in Figure 6. If serial communication method is selected, appropriate pin of serial port must be used corresponding to communication method.

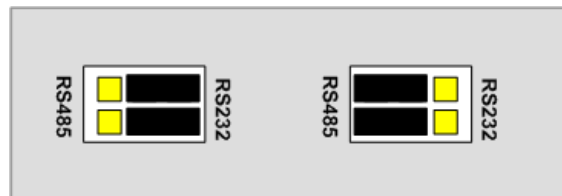

Figure 17. RS232/RS485 communication method setup by RS232/RS485 jumper

3.6 Antenna connection

Connect the SMA-P(male) connector antenna to SMA-J(Female) connector of M110A. At purchase, $\lambda/4$ dipole antenna is provided.



Figure 18. SMA-J Antenna connector

M110A

4. Environment setup

Environment setup can be made through SetModemEnv.exe program. For details, consult the corresponding manual.

4.1 Hardware connection

Use DBG port for PC connection shown in Figure 6.

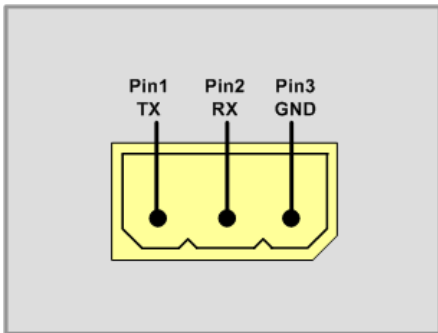

Figure 19. Hardware connection-1(M110A)

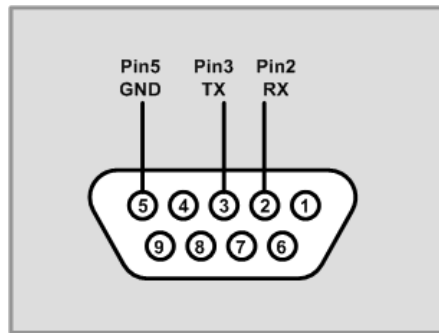

Figure 20. Hardware connection-2(PC)

For communication frequency adjustment, port and PC must be connected via serial communication program as shown in Figure 19.

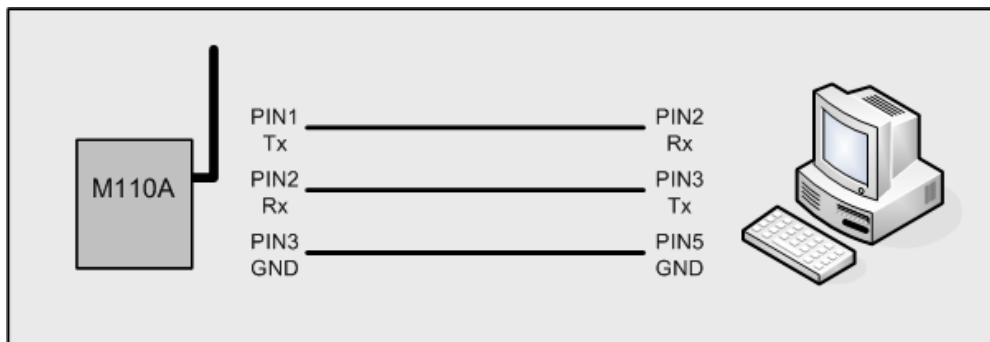

Figure 21. Hardware connection-3

The hardware connection between M110A and PC can be done as shown in Figure 21.

M110A

4.2 Setup list of each mode

4.2.1 PC MODE

- PC/DEVICE MODE Setting : PC MODE Setting
- Channel Setting : Communication Frequency Setting
- Tx Power Level Setting : Communication RF Power Level Setting
- UART Configuration : Select RS232/RS485, Data Bit, Parity Bit, Stop Bit Setting

4.2.2 DEVICE MODE

- PC/DEVICE MODE Setting : DEVICE MODE Setting
- Channel Setting : Communication Frequency Setting
- Tx Power Level Setting : Communication RF Power Level Setting
- DESTINATION ID Setting : DESTINATION ID Setting
- UART Configuration : Select RS232/RS485, Data Bit, Parity Bit, Stop Bit Setting

4.2.3 Environment Setting Program

1) PC/DEVICE MODE Setting(MODE Setting)

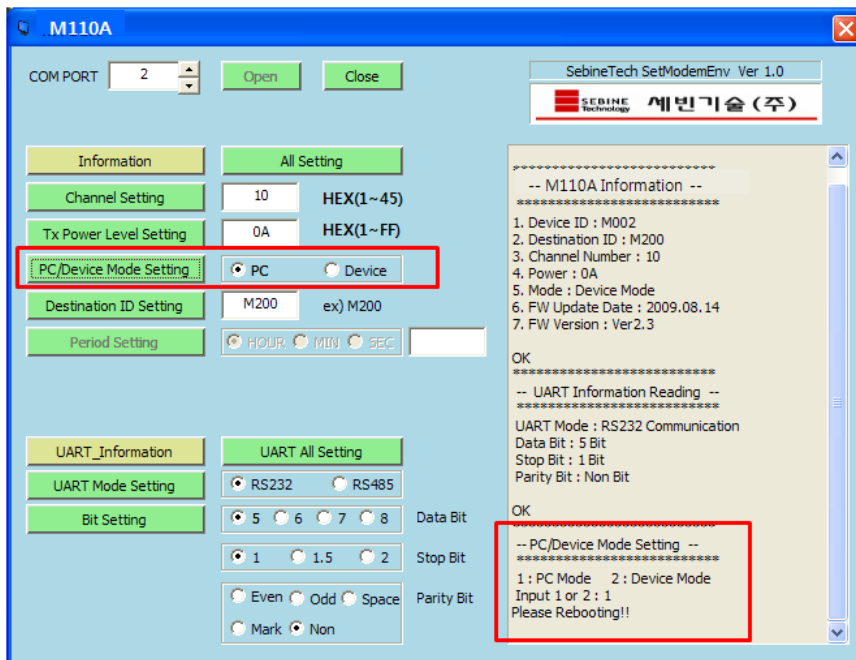

Figure 22. Environment Setting Program-MODE Setting

M110A

2) Channel Setting(Communication Frequency Setting)

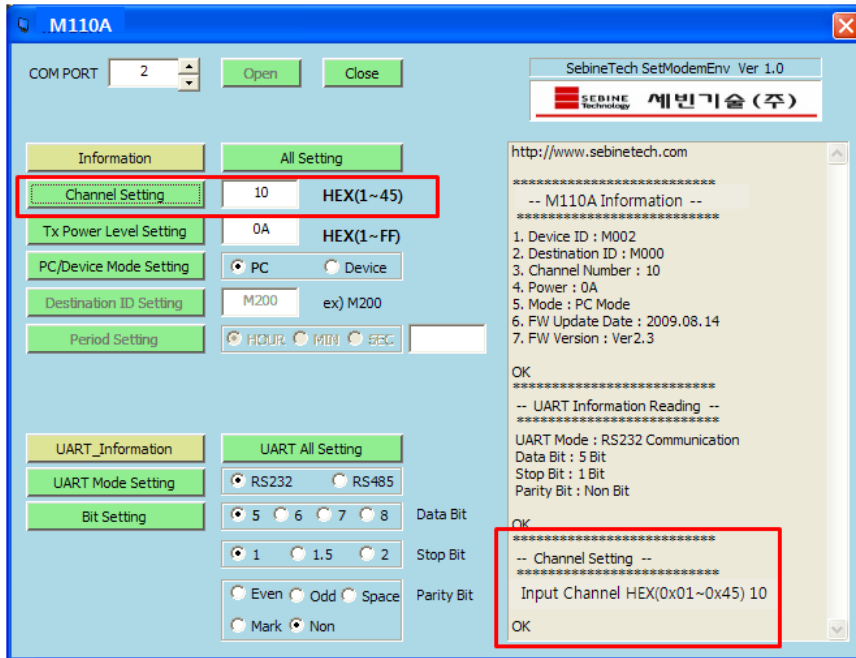

Figure 23. Environment Setting Program-Channel Setting

3) Tx Power Level Setting(Communication RF Power Level Setting)

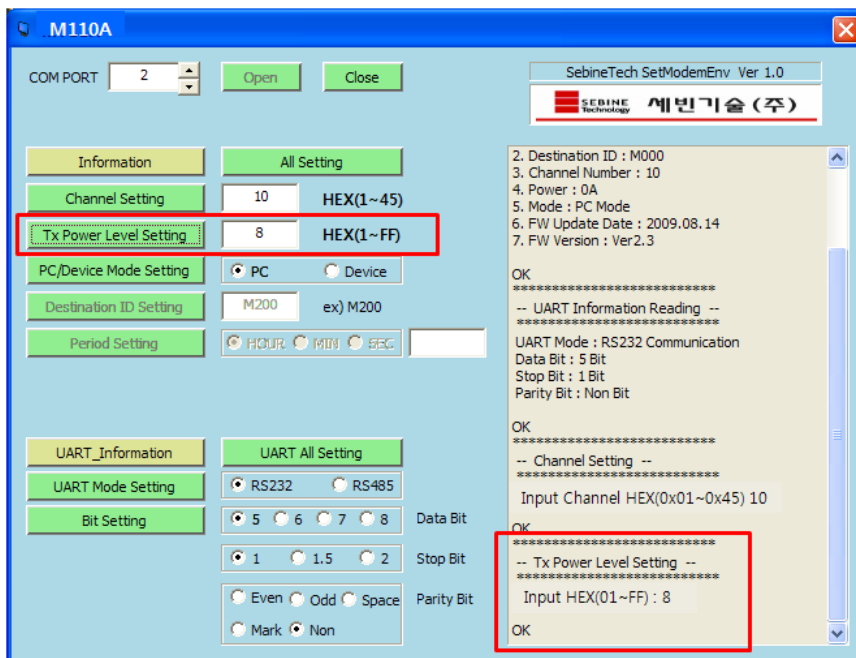

Figure 24. Environment Setting Program-Tx Power Level Setting

M110A

4) DESTINATION ID Setting(DESTINATION ID Setting)

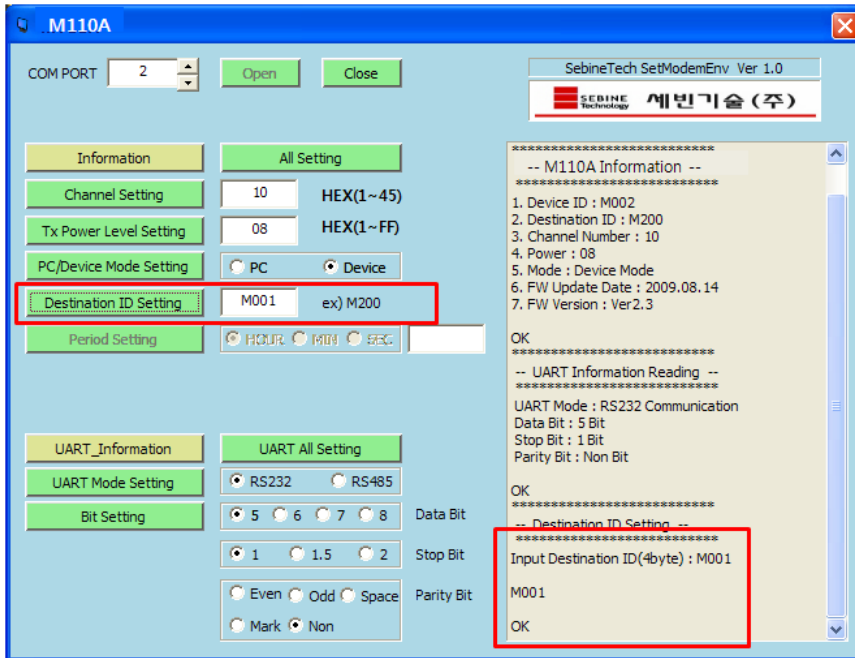

Figure 25. Environment Setting Program-DESTINATION ID Setting

5) UART MODE Setting(UART MODE Setting)

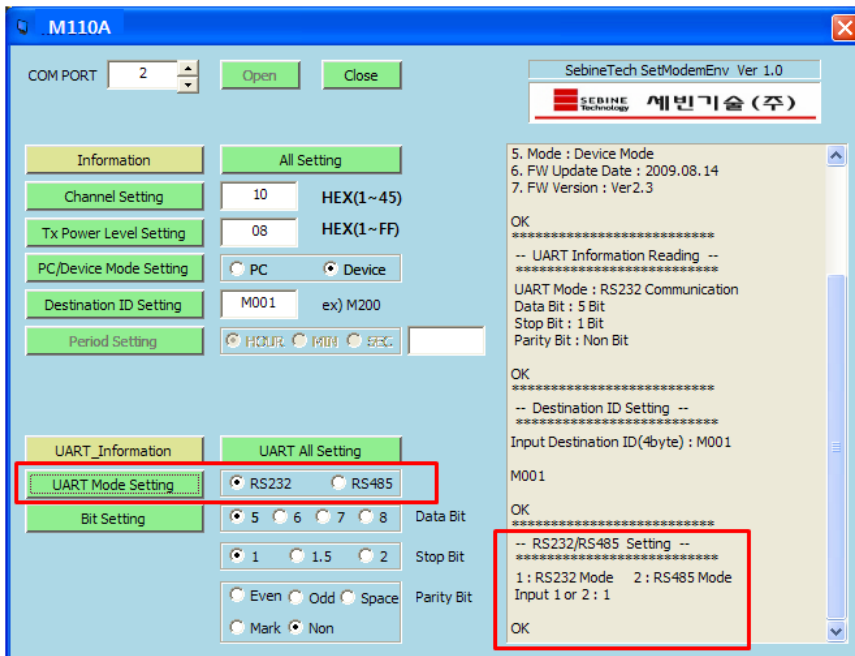

Figure 26. Environment Setting Program-UART MODE Setting

M110A

6) UART Bit Setting(UART Bit Setting)

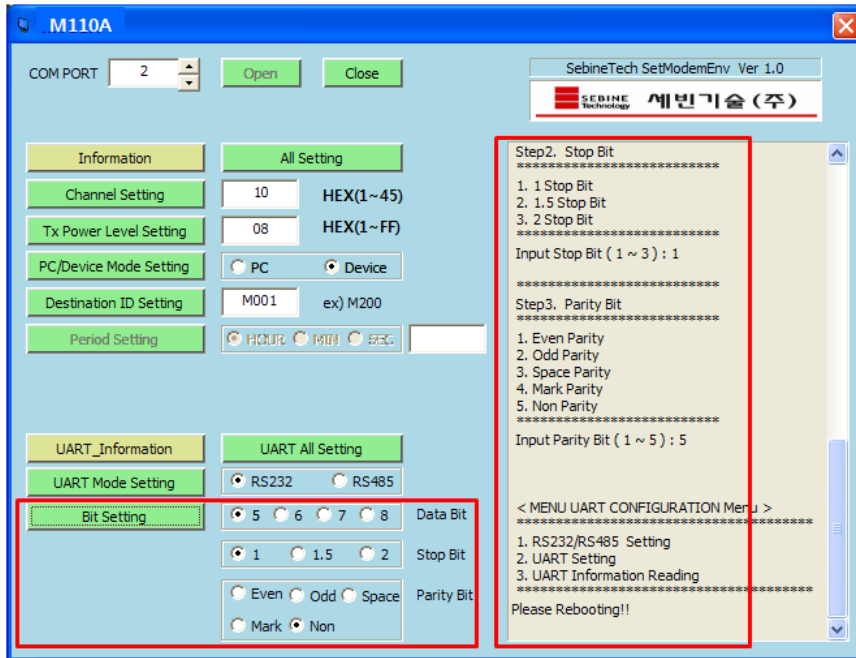

Figure 27. Environment Setting Program-UART Bit Setting

M110A

5. Example

(EX. 1) M110A(PC MODE/DEVICE MODE) to M110A(PC MODE/DEVICE MODE) Communication

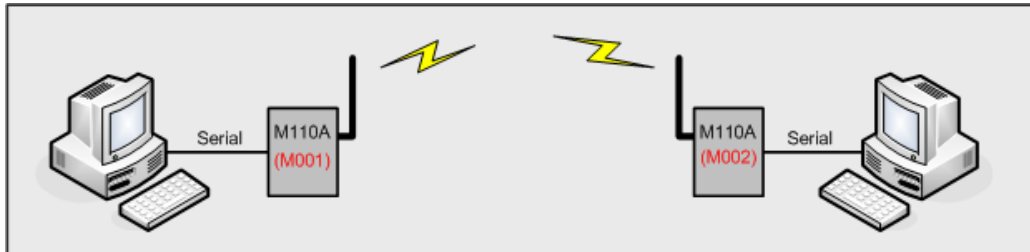

Figure 28. M110A to M110A Communication Example

(EX. 2) M110A(PC MODE) to W110A(PC MODE) Communication

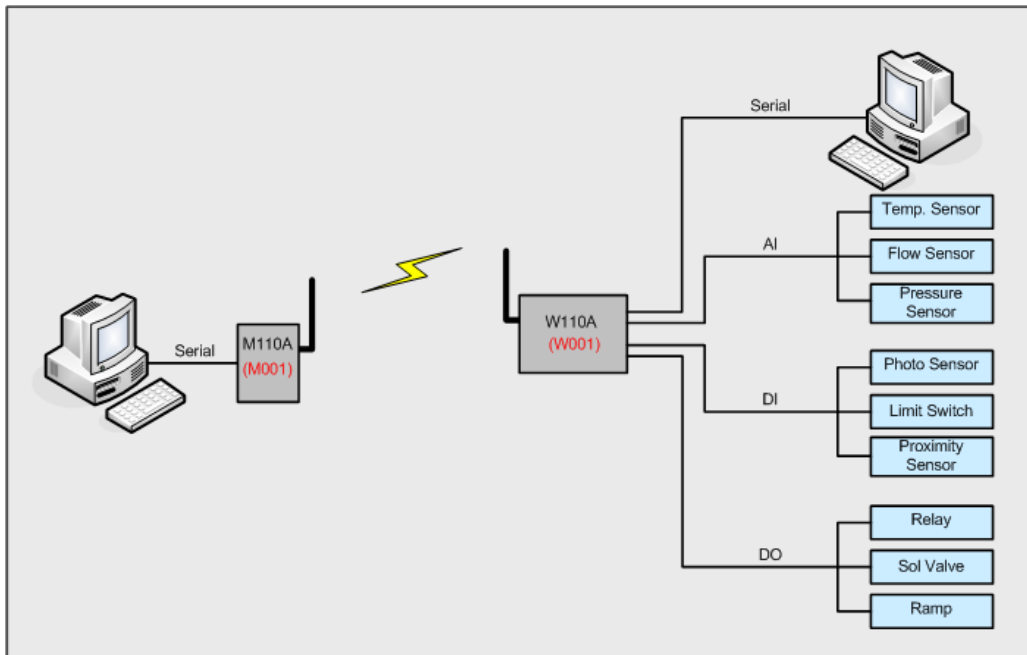

Figure 29. M110A to W110A Communication Example

M110A

(EX. 3) W210A(PC MODE/DEVICE MODE) to M110A(PC MODE) Communication

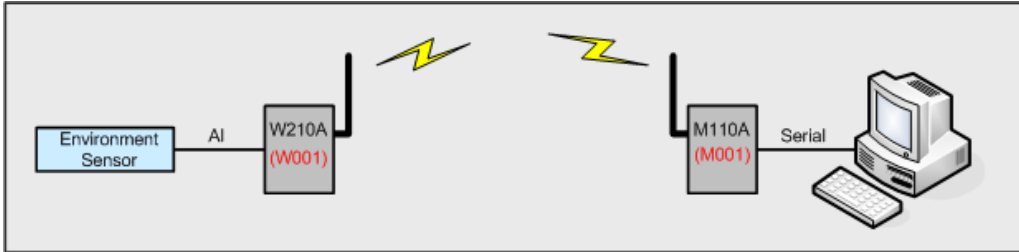

Figure 30. W210A to M110A Communication Example

(EX. 4) W310A(PC MODE/DEVICE MODE) to M110A(PC MODE) Communication

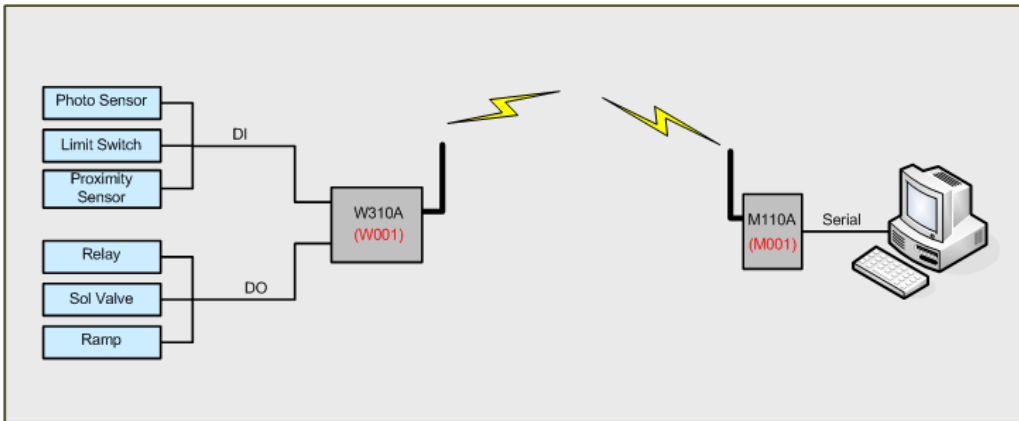

Figure 31. W310A to M110A Communication Example

(EX. 5) W410A(PC MODE/DEVICE MODE) to M110A(PC MODE) Communication

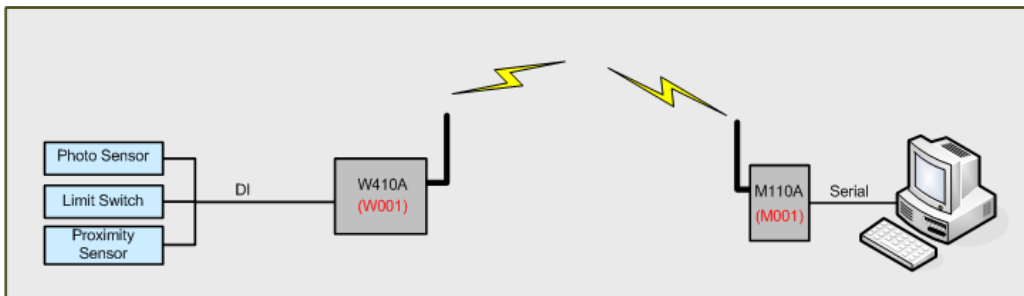

Figure 32. W410A to M110A Communication Example

M110A

(EX. 7) M110A(PC MODE) to W510A(PC MODE) Communication

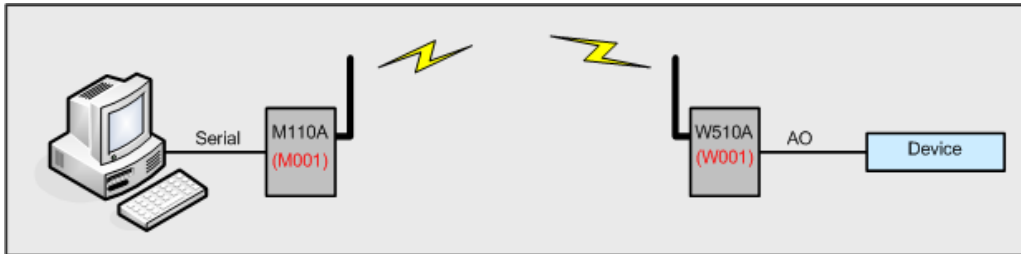
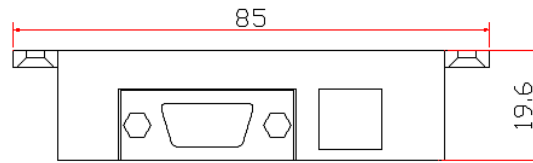

Figure 33. M110A to W510A Communication Example

M110A

Appendix 1. Dimension



BOTTOM

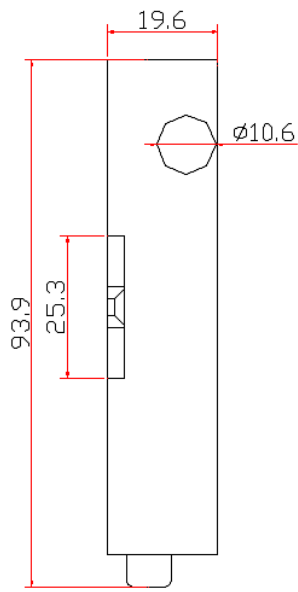

SIDE

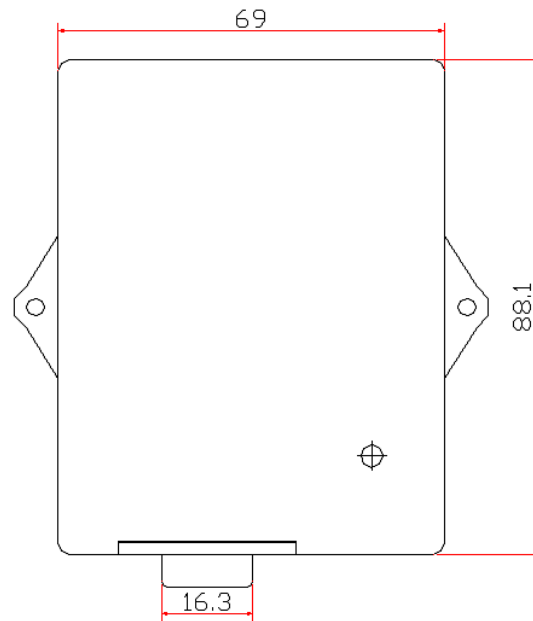

FRONT

M110A

Appendix 2. R&TTE

Hereby, SEBINE Technology, Inc. declares that this device(M/N: M110A) is in compliance with the essential requirements and other relevant provisions of Directive 1999/5/EC.

M110A

Appendix 3. Document Information

Revision	H/W Version	Description
1.0	RF1-AE-RS Ver 1.1	03/30/2009 - Initial Release Version
2.0	RF1-AE-RS Ver 1.1	09/14/2009 - Modified

M110A

SEBINE Technology, Inc.

Homepage : www.sebinetech.com

E-mail : tech@sebinetech.com

#8-116, 187, Techno 2-ro, Yuseong-gu, Daejeon, Republic of Korea 34025
(Migun Technoworld 2, Yongsan-dong)

Tel : 82-42-935-2084, 2085

Fax : 82-42-935-2088